



1477609F
HIC
-2309F
82020

AIS
IoT

AIS 4G Board

Simplify Development of IoT Solutions
with the best 4G coverage

AIS 4G Board



AIS 4G Board is the development kit for rapid prototyping of highly secure, and compatible with Microsoft's Azure IoT PaaS and SaaS. The board includes eSIM for 4G connectivity and integrated sensors.

UART
I2C
GPIO
RS485

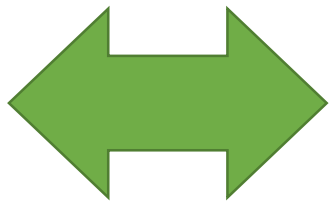

3G/4G,
Wi-Fi

MQTT
HTTP

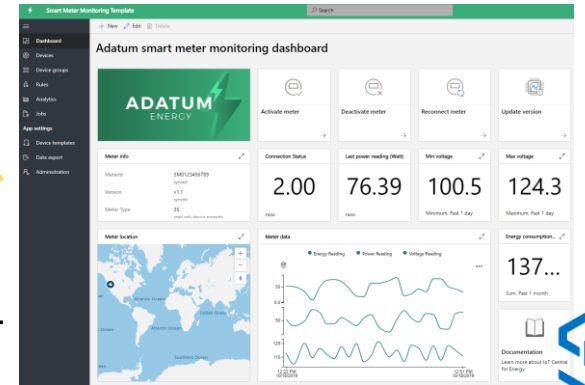

Azure IoT Central

AIS
4G Board



https://github.com/gravitech-engineer/AIS_IoT_4G

Benefits for Business

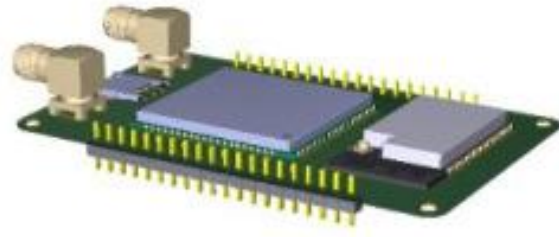

Rapid Prototype



Nationwide Signal Availability



Azure
Certified
Device

MS Certified Device

Key Features

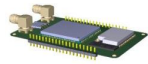

Design

- Dimension (mm): 58 x 107 x 19.5 mm
- Weight (g): 42 g

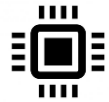

Micro Controller

- Brand: Espressif
- Model: ESP32-WROOM-32



Connectivity

- Cellular: 3G/4G (LTE CAT4)
- SIM Card: eSIM
- Wi-Fi: Yes (802.11 b/g/n)
- Bluetooth: Yes (Version 4.2)



Sensors

- GPS: Yes
- Temperature: Yes
- Humidity: Yes



Addition Include

- Micro SD card slot
- eSIM on Board
- GPS and 3G/4G Antena
- RS485

Differentiation

- ✓ Compact MCU with 4G module in single board – reduce wiring complexity
- ✓ Special price for 4G package – only 500 THB/year
- ✓ e-SIM on board - reduce sim contact problem
- ✓ Azure Certified Device – Easy to integrate with Azure platform (IoT Hub & IoT Central)
- ✓ Addition – GPS & Micro SD card slot are included
- ✓ GitHub example code is provided - https://github.com/gravitech-engineer/AIS_IoT_4G

Example use case - Factory

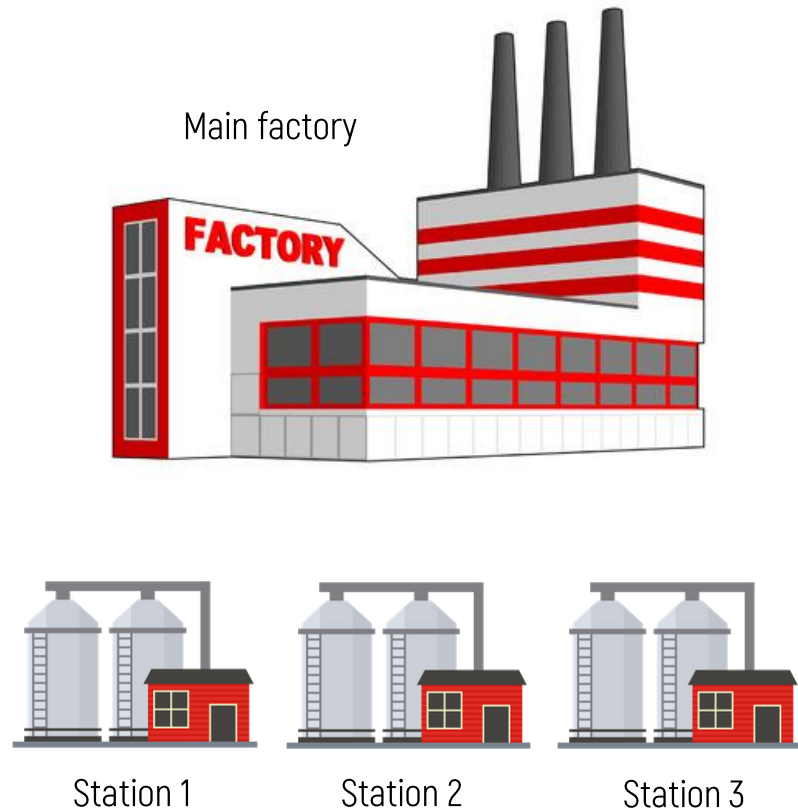

4G/3G
GPS

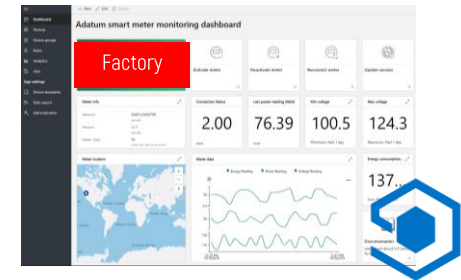
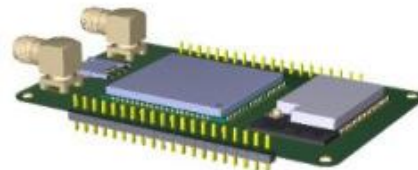

Azure IoT Central

- Remote Monitoring
- Hazardous Detection
- Standalone station
- OEE Monitoring

Example use case - Telemetry Station

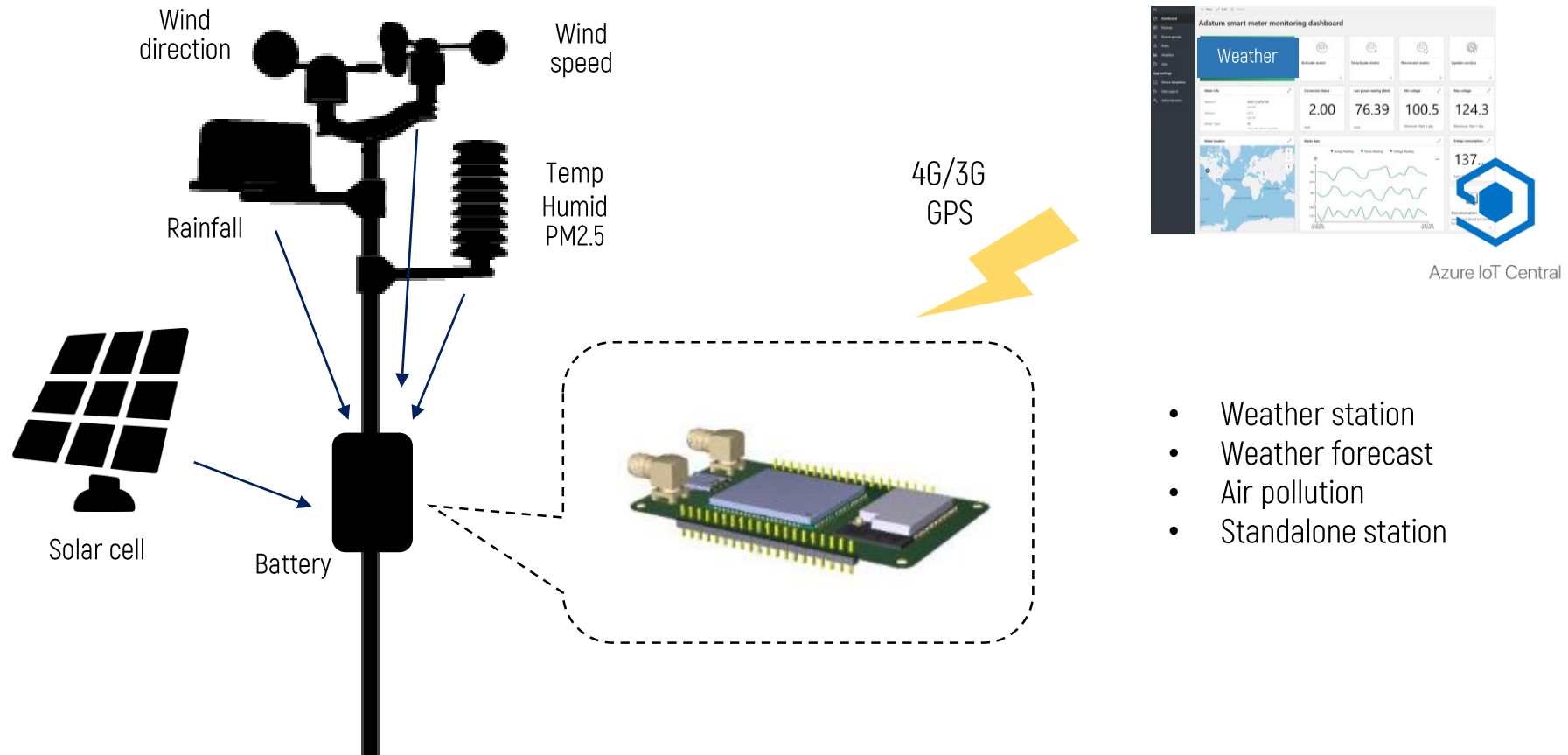

- Weather station
- Weather forecast
- Air pollution
- Standalone station

Example use case - Smart Farm

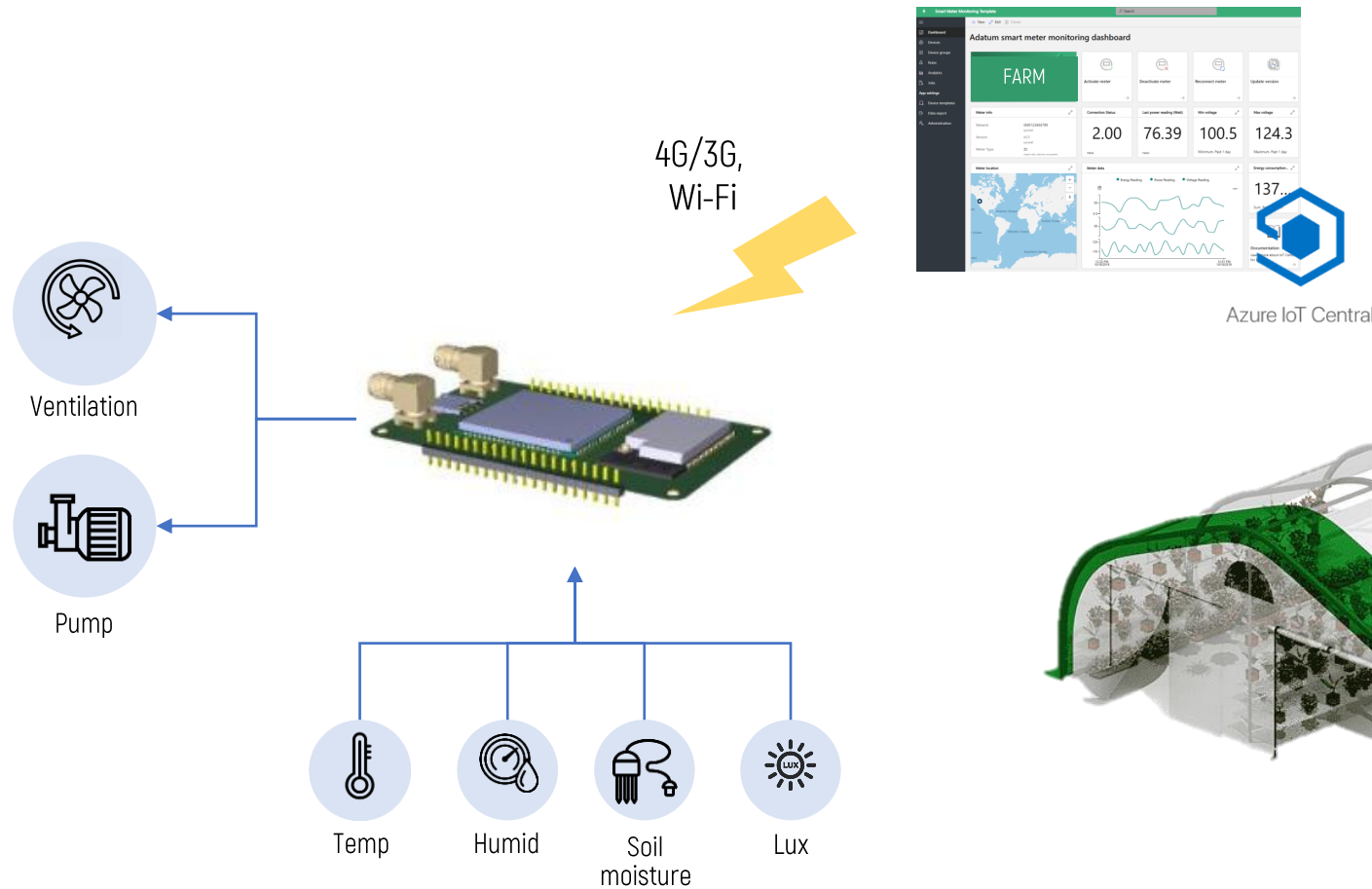

- Farm Monitoring
- Farm automatic control
- Save manpower

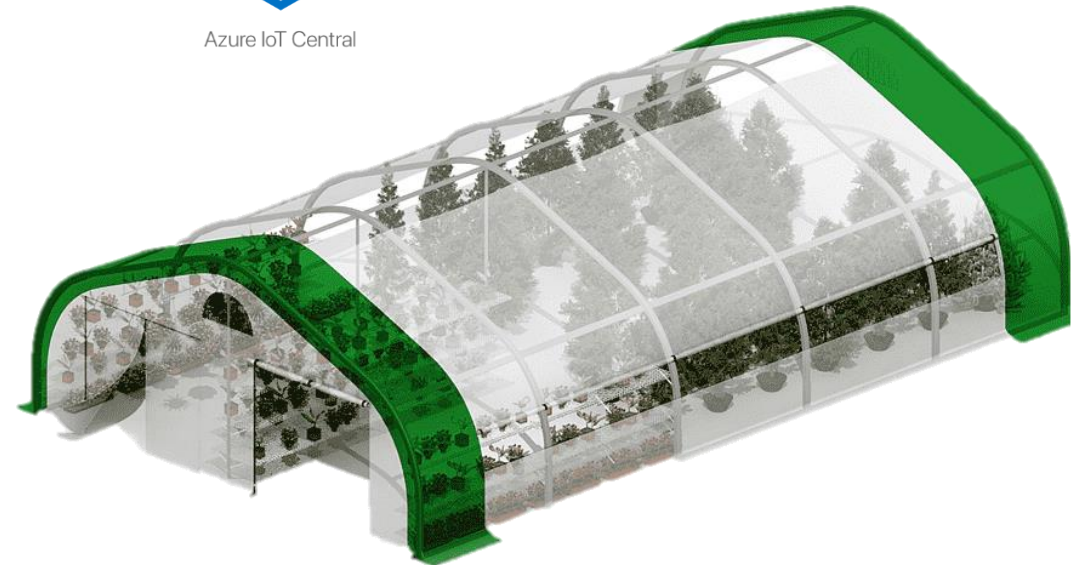

Example use case - Smart meter

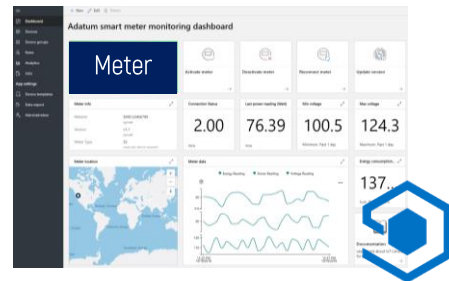
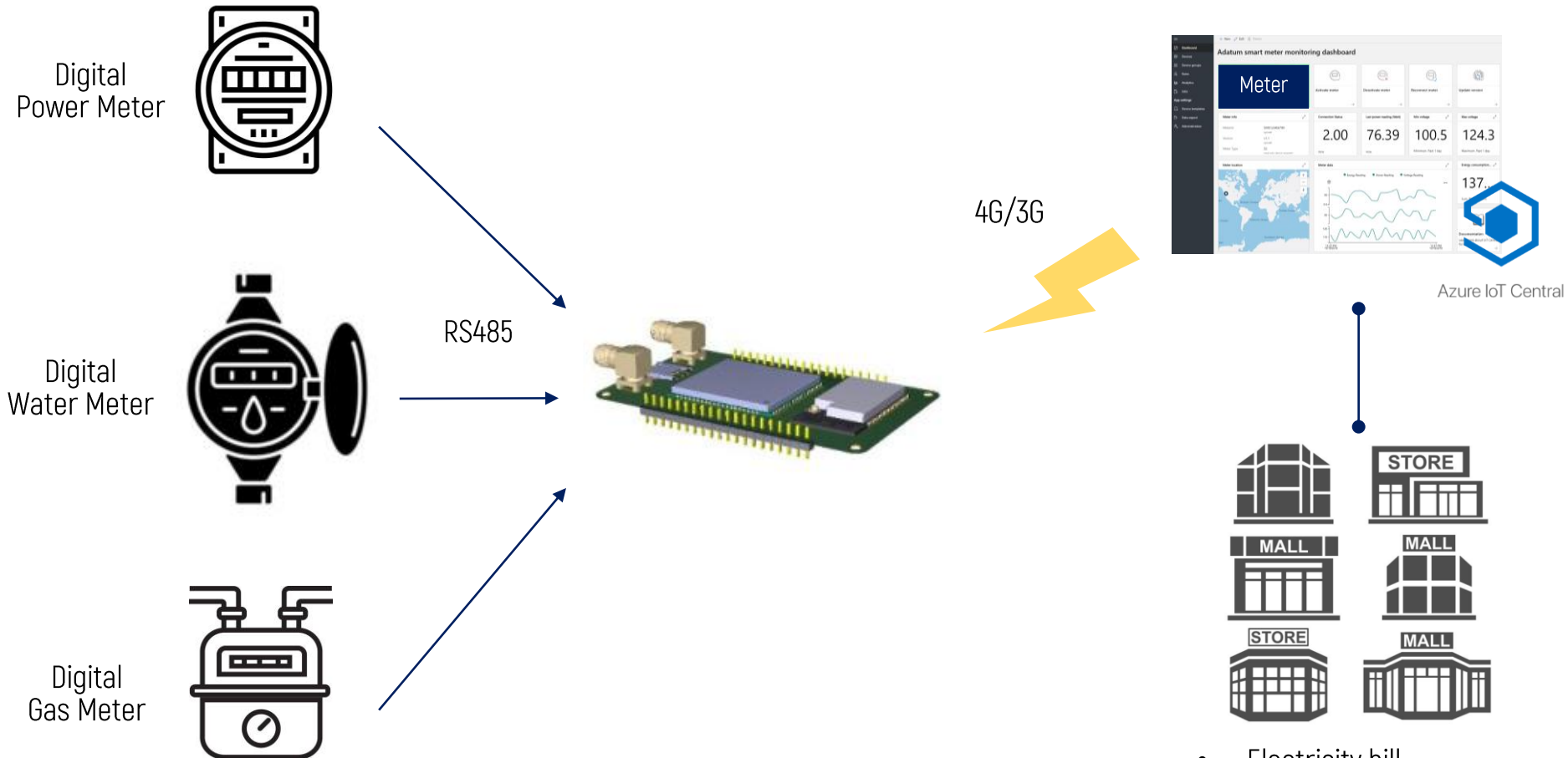

- Electricity bill
- Analyze energy consumption
- Preventive maintenance
- Save manpower
- Reduce energy consumption

AIS 4G Board + Azure IoT Central (SaaS)

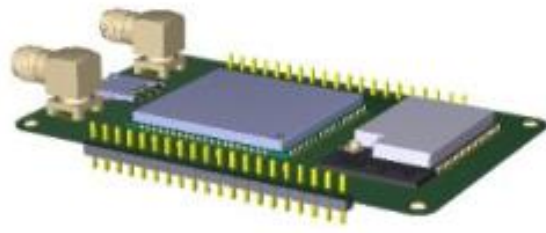

telemetry



command

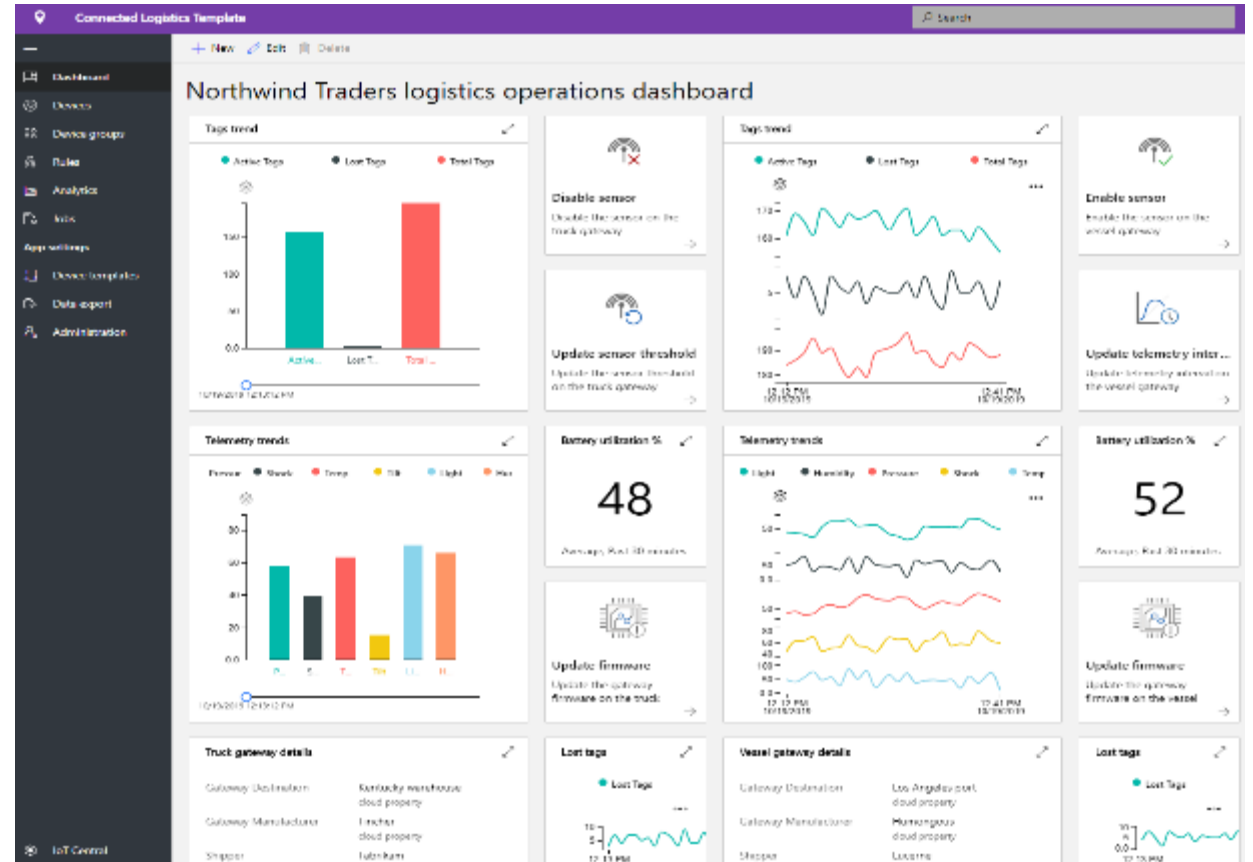

- Device Management
- Dashboard & Visualization
- Monitoring rules & Triggered actions
- User role & permissions

- White Label
- Public APIs

Device (AIS 4G Board) (Onetime)

Special
Free Airtime
Package
1 Year

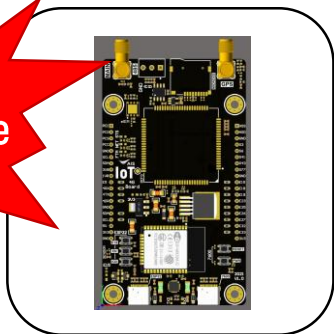

Item	Price
Device <i>(+ 1 Year Airtime Package)</i>	3,600

* รับประกัน 1 ปี เปลี่ยนสินค้าได้ภายใน 7 วัน ตามเงื่อนไขที่กำหนด



Airtime Package (Recurring - Yearly)

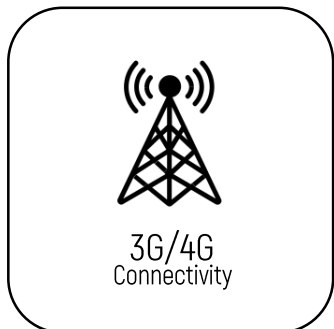

Airtime	Package
500 THB	Unlimited 384 kbps