

inetum.™



# POC Data & Analytics Plateforme data

Microsoft Fabric an all-in-one solution

Sales proposal

# CONTENTS

1. The Microsoft Fabric solution
2. Approach and methodology
3. Use cases and Reference
4. Inetum BU MS Cloud support proposal

# Microsoft Fabric



Data Factory



Synapse Data Engineering



Synapse Data Warehouse



Synapse Data Science



Synapse Real-Time Analytics



Power BI



Data Activator (coming soon)



OneLake

# Intelligent Data Platform

- ❑ Microsoft Fabric is an innovative solution that recognizes the foundations on which AI builds its ability to understand and make decisions.
- ❑ Microsoft Fabric transforms the raw power of data into a force that drives the evolution of AI, coherently bringing together modern data structures, data engineering and data science on a shared SaaS foundation.
- ❑ Microsoft Fabric lets you leverage all your data by simplifying the work of all your teams in a single, easy-to-use, unified intelligent data platform.
- ❑ Copilot in Microsoft Fabric offers advanced generative AI features enabling data professionals to interact with the platform in a particularly productive way. You can empower your team to take advantage of AI by preparing your data for use by innovative ML tools and copilot

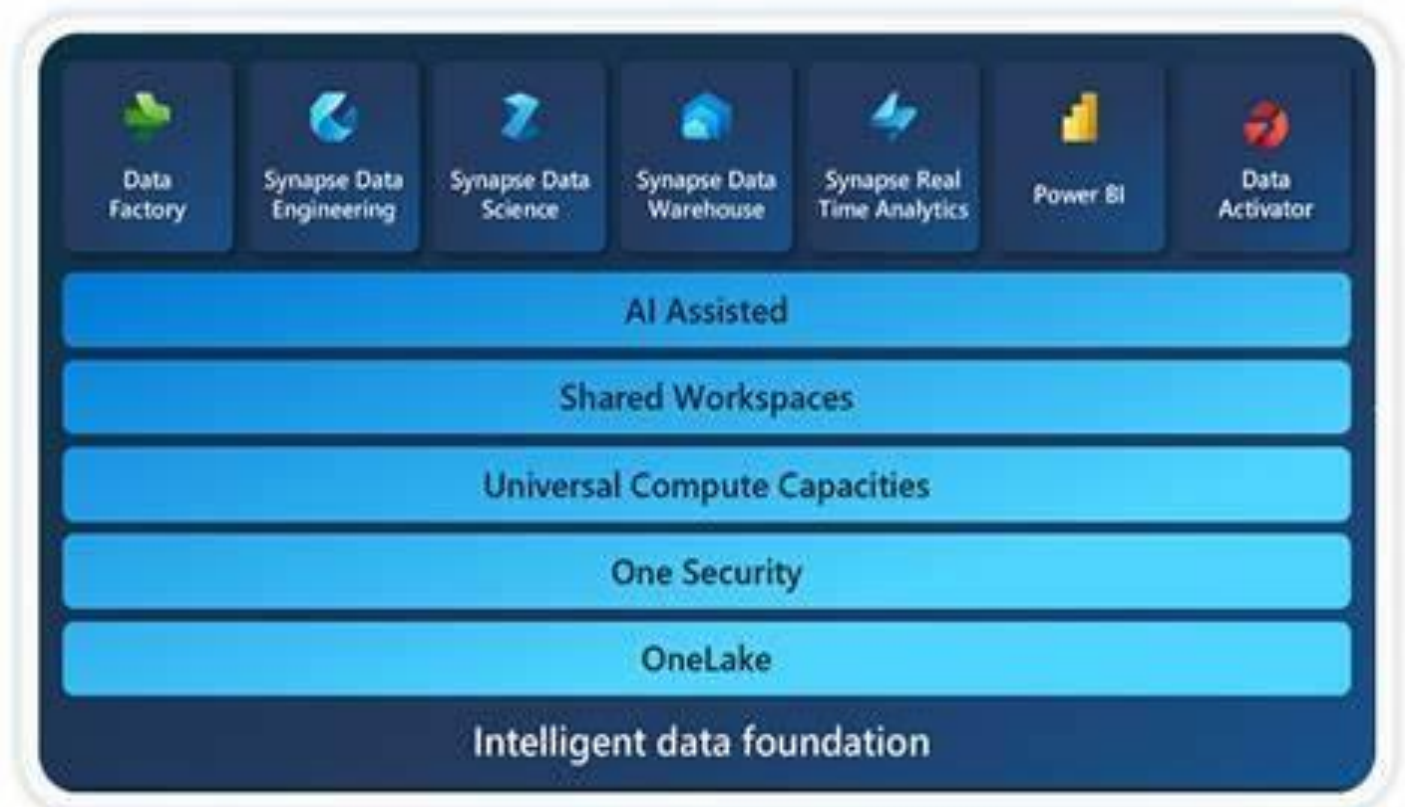

# Why MS Fabric?



Core Architecture Ms FABRIC

The ultimate data platform for all your needs, bringing together all data players in a single collaborative space in SAS mode, enabling you to:

- Unify your data assets
- Manage powerful AI models
- Empower everyone in your organization
- Govern data across your organization

## MS Fabric highlights

- MS Fabric lets you build a practical, prescriptive data management and analysis strategy as quickly and efficiently as possible.
- You have experience of running projects using Fabric's underlying tools: Data Factory, Synapse Data Engineering and Data Science, Synapse Data Warehousing, Azure Storage.
- Obtain a semantic data model to define the relationships between stored data and businesses and maintain data consistency
- Configure your Azure environment to be secure and reliable, while minimizing costs
- You can get advice from a large community of Azure solution experts.

# Working with OneLake

- Data flows through a single datakit called "OneLake".
- A single DataLake enables collaboration between the various players working on data, and provides a complete decompartmentalization facilitating access to different services.
- OneLake offers scalable file storage for relational objects via metadata and the Delta Lake table format.
- Complete isolation between storage and compute
- OneLake Explorer" data explorer facilitates secure access to data
- Connector performance to source data in Direct Query mode on DataLake with the advantages of import mode

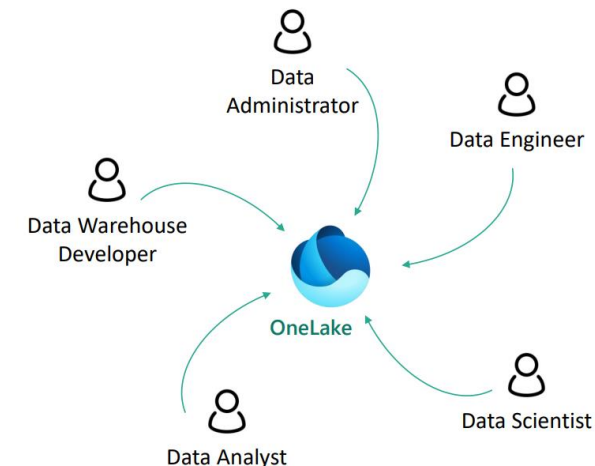
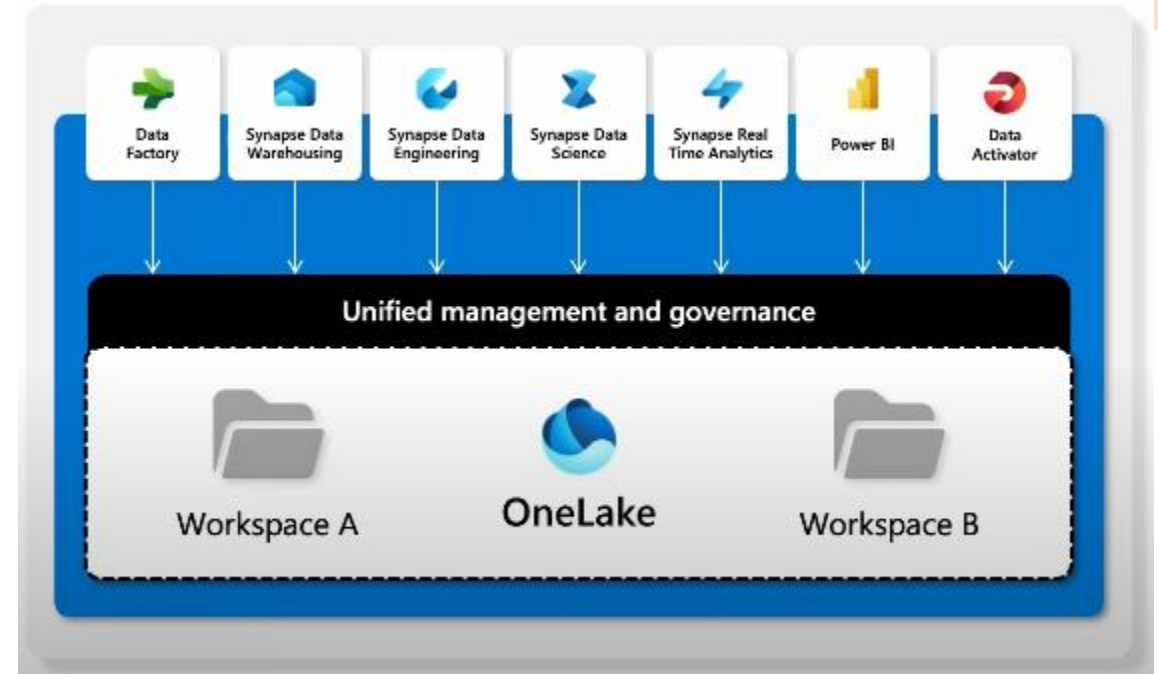

# Data Engineering with Microsoft Fabric

On the Data Engineering service, you'll find options for creating commonly used data engineering resources. Microsoft Fabric provides several services You can manage :

- ✓ Data pipeline orchestration, similar to Azure Data Factory, to manage data copies and orchestrate activities.
- ✓ Integration and data processing, Notebooks for easy Spark authoring, quick start-up with live pool clusters for code execution, and VS Code as a local IDE for development.
- ✓ On Fabric, Dataflow Gen2 is an evolution of Power BI dataflow, providing a Power Query environment for data transformation, as it is possible to cleanse, transform and develop on the interface only without coding in M

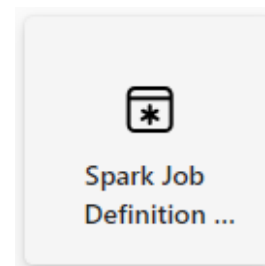
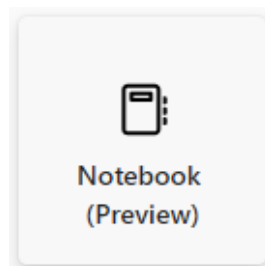
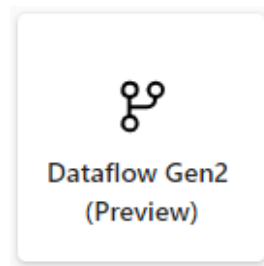

# Data science with Microsoft Fabric

With data science in Microsoft Fabric, you can :

- ✓ Use the power of ML machine learning features to seamlessly enrich data and analysis workflows.
- ✓ Data science has become crucial for modern businesses, enabling informed decision-making and predictive insights by harnessing the power of analytics.

Data science experience in Microsoft Fabric includes :

- ✓ Notebooks in synapse data science
- ✓ MLflow models and experiments.
- ✓ Cognitive services
- ✓ Data Wrangler
- ✓ Direct impact with DirectLake

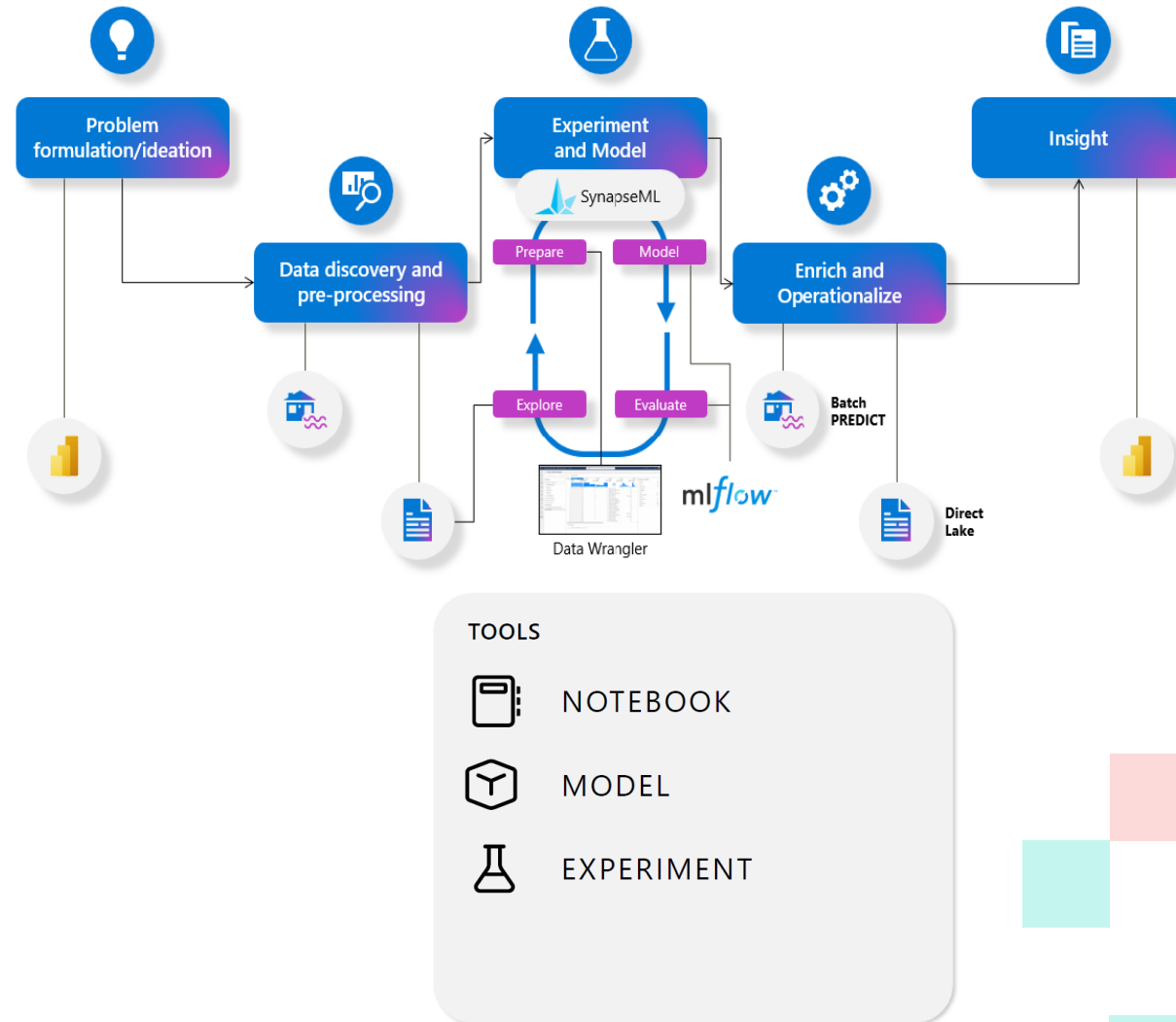



# Governing your data with Azure Purview



**Azure Purview** is a unified data governance service that combines the power of a data catalog tool with **data cataloging**, data **linearization** and data **governance** as a software service.

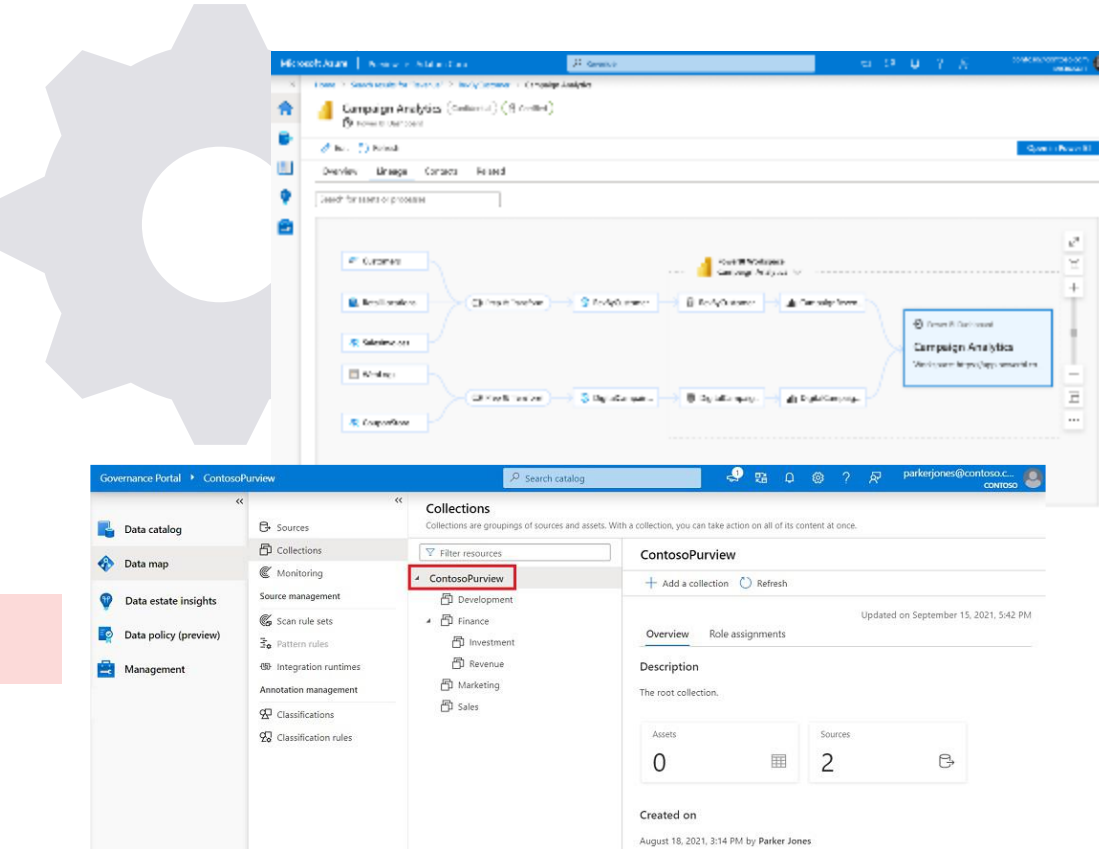

- Scan data sources and automate **data classification using built-in classifiers** and the Microsoft Information Protection (MIP) **security tool. tag sensitive Data**
- Azure Purview is compatible with **Azure, Power BI, Microsoft 365** and can support on premise or other cloud sources
- Retrieves **only metadata** (technical, commercial, semantic and operational) from the various sources; **no data is entered into the tool.**
- Perform **automatic Data Lineage** to trace the complete data lifecycle and know where your data comes from, thanks to interactive visualization of data traceability.
- Search for data based on technical or commercial terms and quickly identify the **level of data sensitivity.**

# Architecture design and implementation

You can deploy the services in just a few clicks, and they're fully managed.

Microsoft Fabric includes all the services you need to build the platform best suited to your needs

Microsoft Fabric streamlines the complexities of architecture design with "One Architecture".

It does, however, offer a variety of options and models, enabling users to customize their experience and maximize their potential according to their needs.

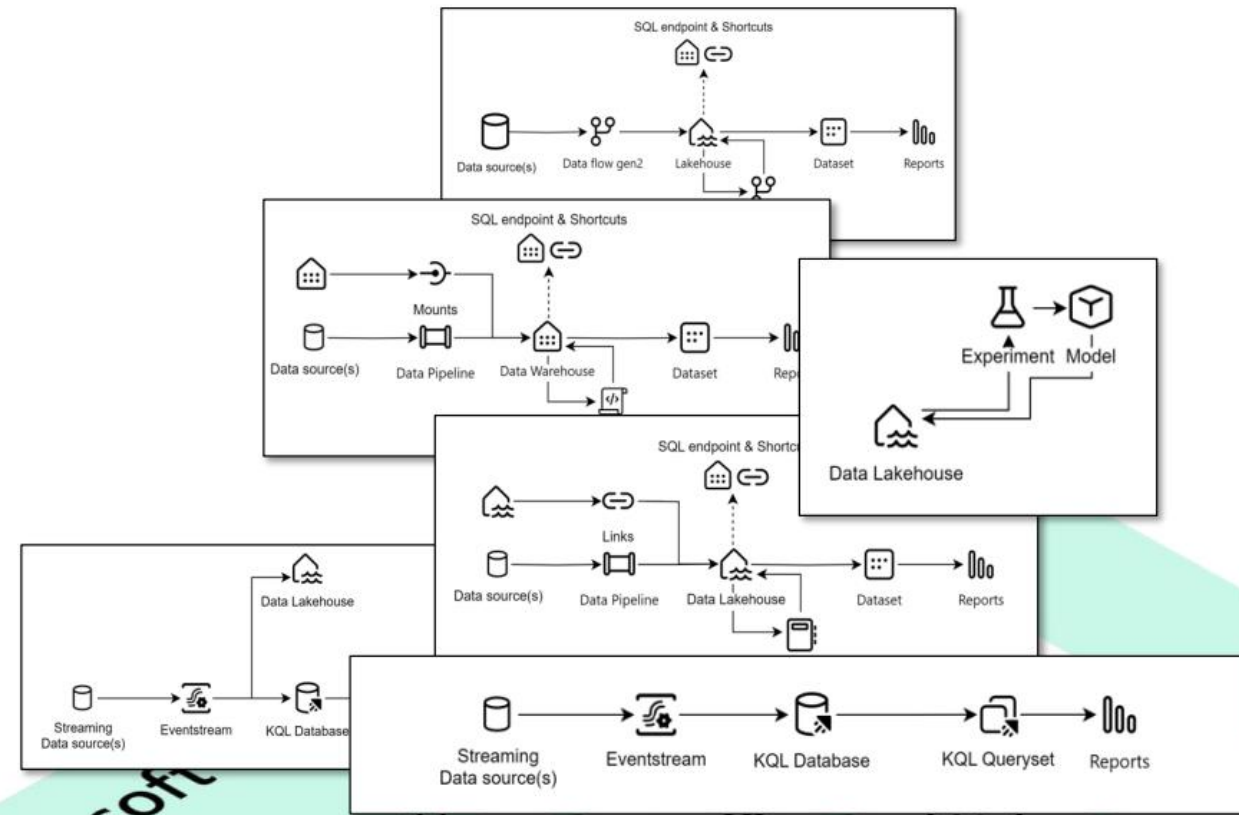

# Organisation Product as a service

You can adapt the architecture of your data platform to your business organization and the maturity level of your end-users:

- Fully decentralized domains (based on data mesh)
- Centralized
- Or hybrids



CAPACITY



DOMAIN



WORKSPACE

ENTERPRISE

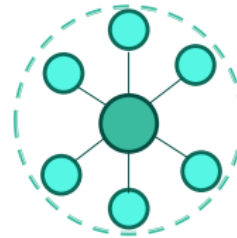

HYBRID



SELF-SERVICE

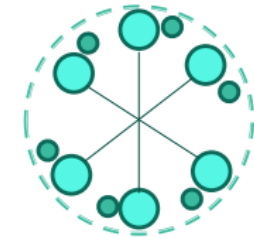

# Medallion architecture with Microsoft Fabric

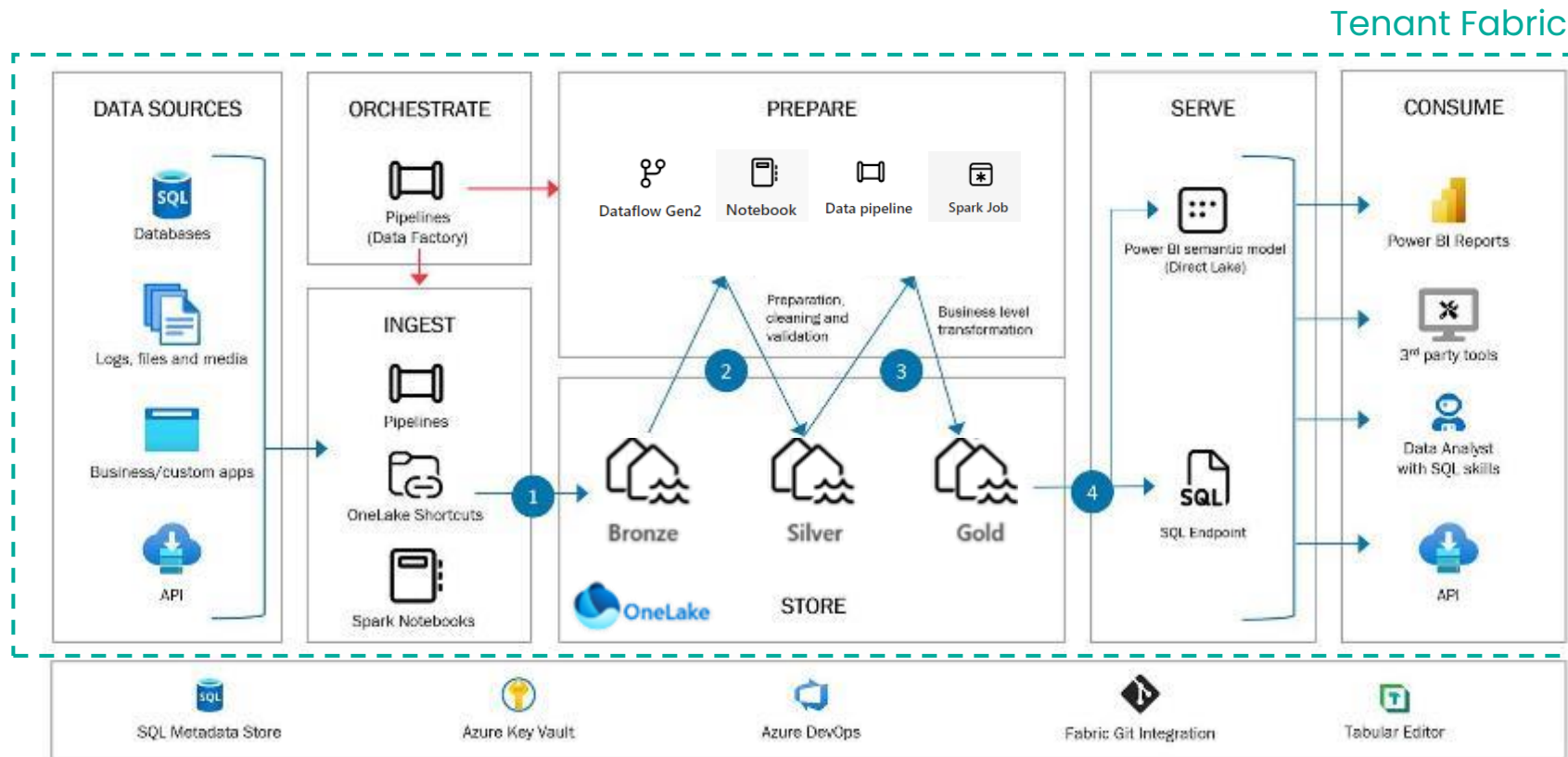

# Amplify Copilot in Microsoft Fabric

Copilot in Microsoft Fabric offers advanced generative AI functions, enabling data professionals to interact with the platform in a particularly productive way.

- ✓ **Copilot for analysis**, integrate and analyze the relevant data into a report.
- ✓ **Copilot for DAX** allows rapid customization of reports, generation and modification of DAX code in **Power BI**
- ✓ **Copilot for intelligent Q&A**, allows you to create narrative summaries and ask questions about data, all in a conversational language.
- ✓ **Copilot in Fabric**, increases end-user productivity and value generation without technical training.

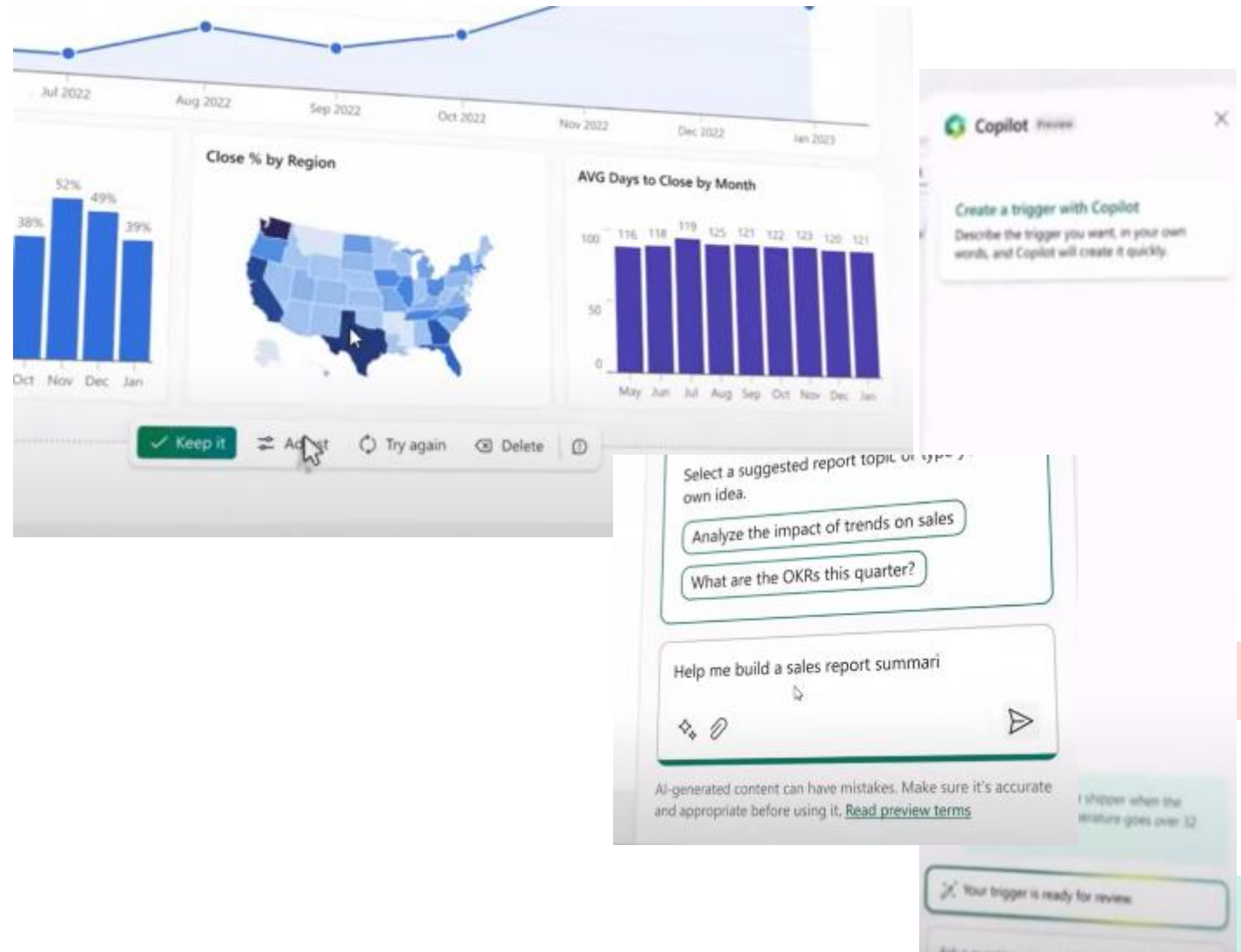

# MS Fabric Pricing & costs

Microsoft Fabric offers a variety of purchasable capacities divided into SKUs, each offering a unique amount of computing power quantified by capacity units (CU).

Fabric includes two types of SKU:

- Azure: billed by the second, with no commitment.
- Microsoft 365 – Billed monthly or annually, with a monthly commitment

SKU*	Capacity Units (CU)	Power BI SKU	Power BI v-cores
F2	2	-	0.25
F4	4	-	0.5
F8	8	EM/A1	1
F16	16	EM2/A2	2
F32	32	EM3/A3	4
F64	64	P1/A4	8
F128	128	P2/A5	16
F256	256	P3/A6	32
F512	512	P4/A7	64
F1024	1024	P5/A8	128
F2048	2048	-	256



# Approach and methodology

# Build Your AI-Forward Unified Data Foundation with Fabric

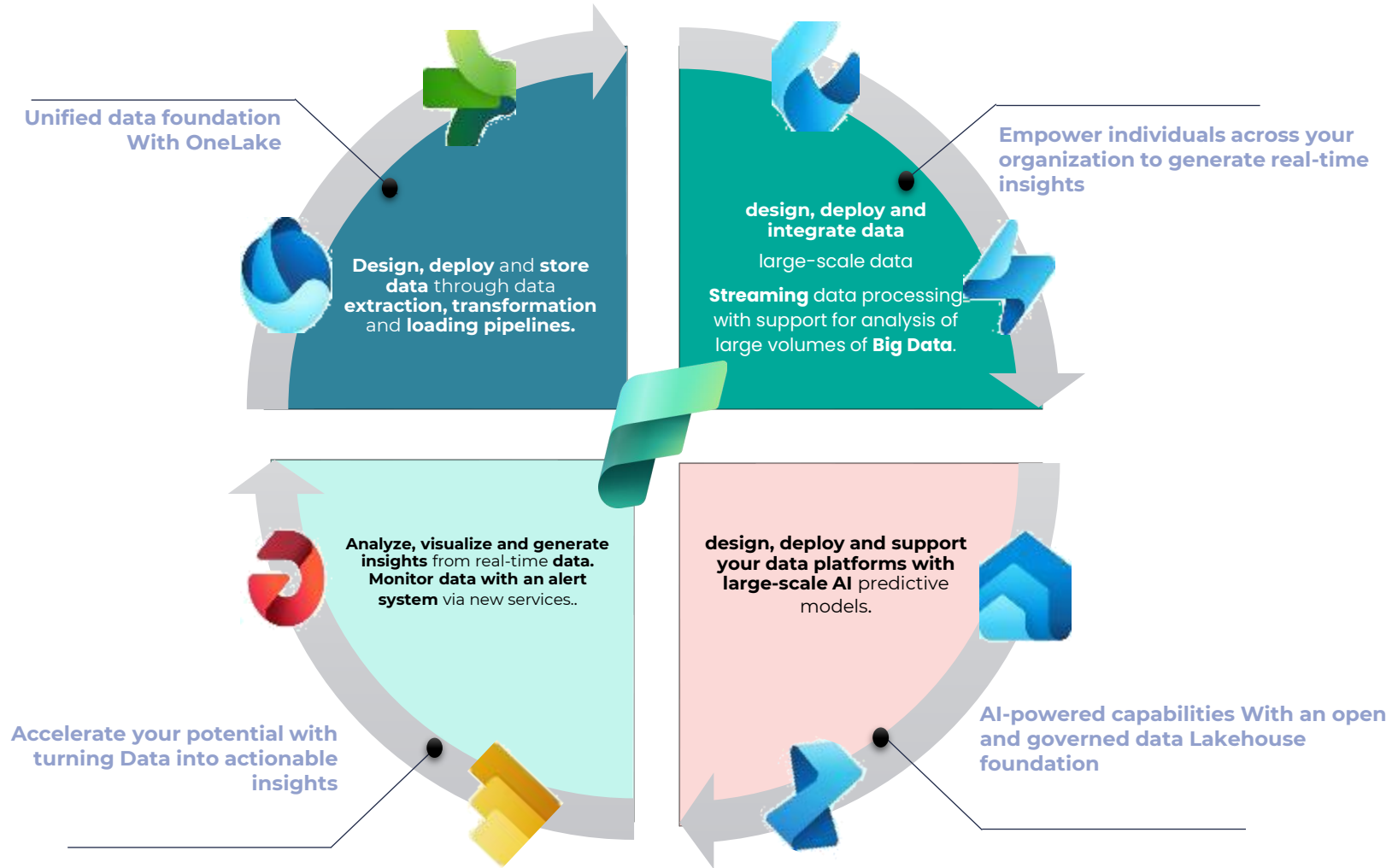

Microsoft Fabric



# Areas of expertise Data & AI

Our areas of expertise and skills have a real impact on companies' businesses

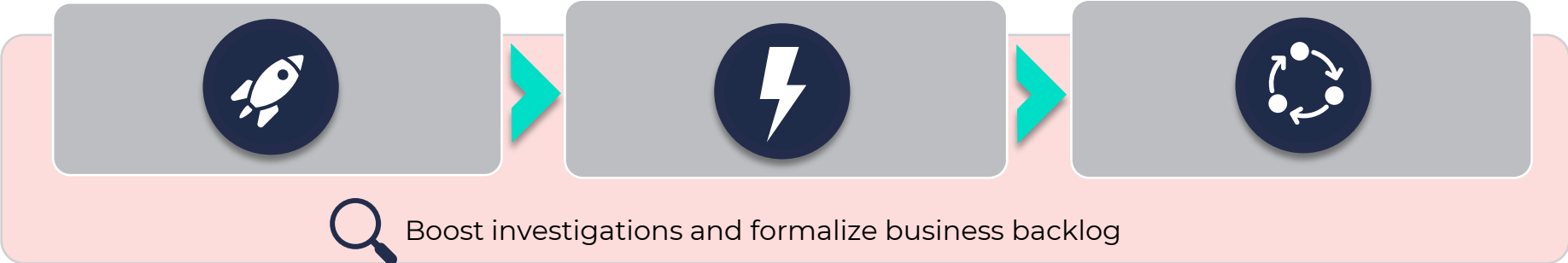

**Design,  
operate &  
Build your  
unified Cloud  
Data  
Foundations**

Quickstart Data Lakehouse  
Data & infrastructure  
**Migration**  
Cloud Security  
Assessment

**Analyze,  
visualize &  
Turning your  
Data  
into actionable  
insights**

Quickstart DataOps &  
automated ingestion with ADF  
**Self service BI** framework for  
Power BI  
Data Analytics  
Assessment

**Activate your  
data  
empowerment  
And  
governance**

Quickstart Purview &  
Automated  
**Self service BI** framework for  
Power BI  
Data Analytics  
Assessment



Training, tools and knowledge

# Our support

- **Assimilation** and framing of your needs and customer use cases
- **Technical feasibility study** and qualification of your Data solutions
- **Creative** design with your intelligent, unified data platforms

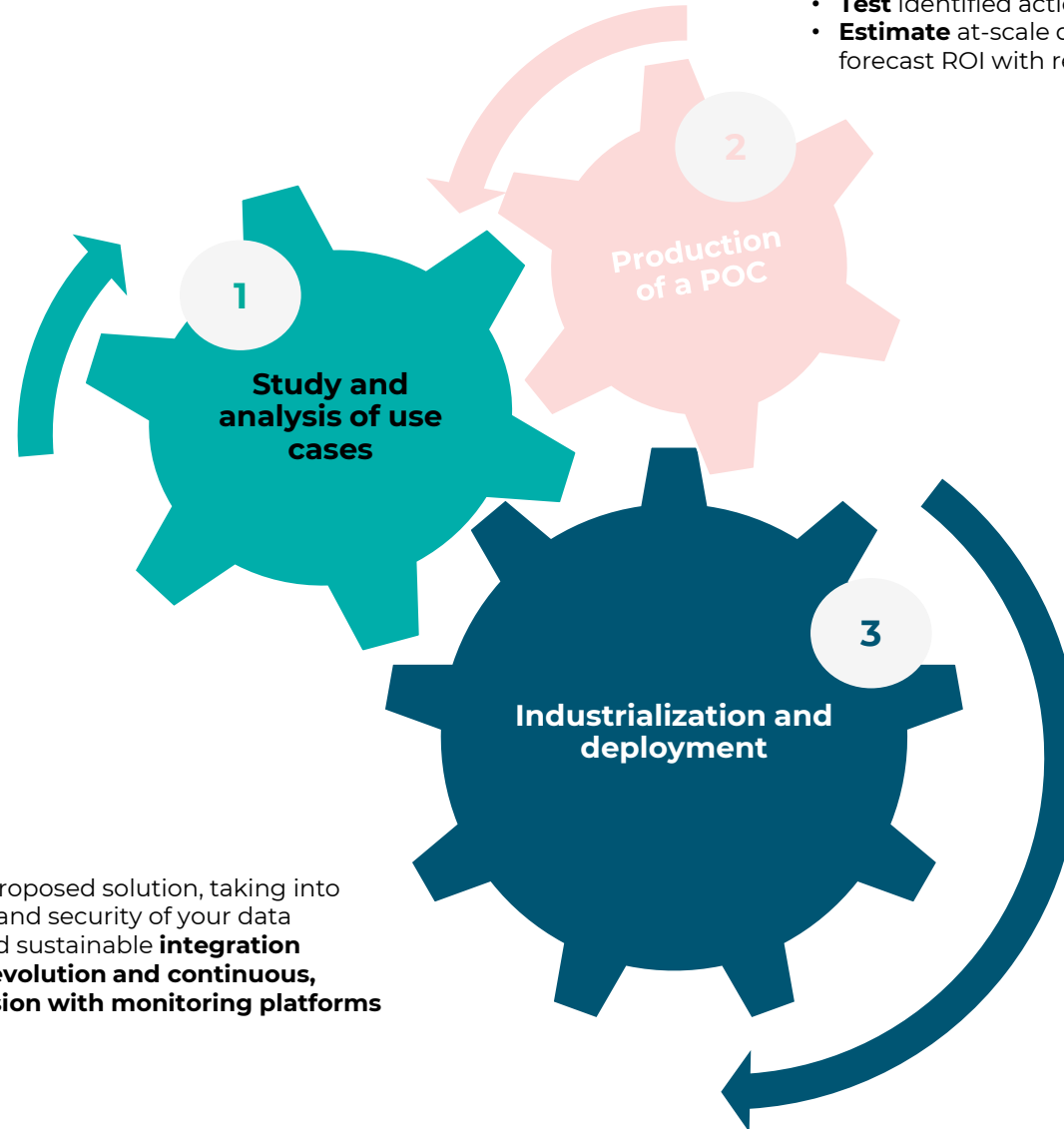

- **Get an overview** of the services and functions covered by MS Fabric
- **Test** identified actions on your own data
- **Estimate** at-scale deployment costs and forecast ROI with revenues

- **Implementation** of the proposed solution, taking into account the governance and security of your data
- **Creating** added value and sustainable **integration**
- **Ensure optimal service evolution and continuous, comprehensive supervision with monitoring platforms**

# Our use cases

# Data platform: Example of architecture

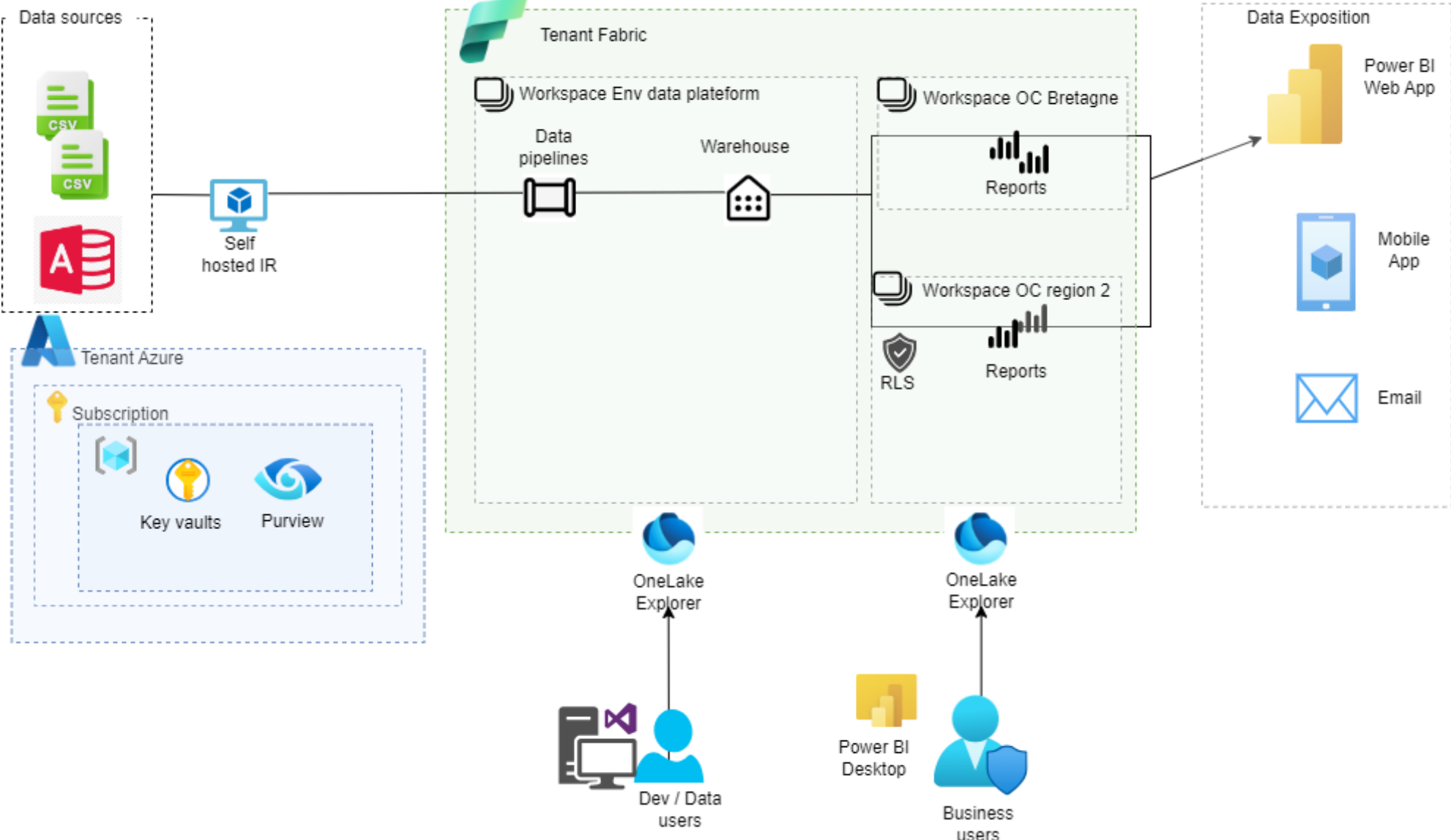



**Thank You**



**inetum.**  
Positive digital flow



**inetum.com**