



Perfios Credit Gateway

Connecting Money

Challenges



Scaling

Scale the network, handle labyrinth of Integrations



API & Whitelabelled

Technology to provide both API & Whitelabelled solution



Data for underwriting

Handle different data such as partner data, bank statement, GST, ITR, Salary slip, augmented data via AA, e-Statement, scanned, etc for underwriting



OCEN & Non-OCEN

Few partners will be on OCEN, existing partners have their own proprietary tech platform suited for their use case



Multiple use case

Handle multiple use cases like AL, PL, HL, BNPL



Ops

Handle reconciliation, MIS with partners, product returns in BNPL

Current Implementation

Consumers

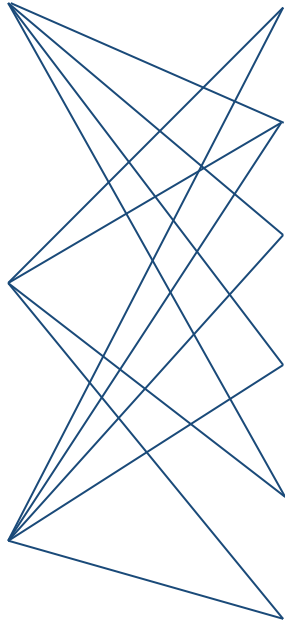

Customised implementation

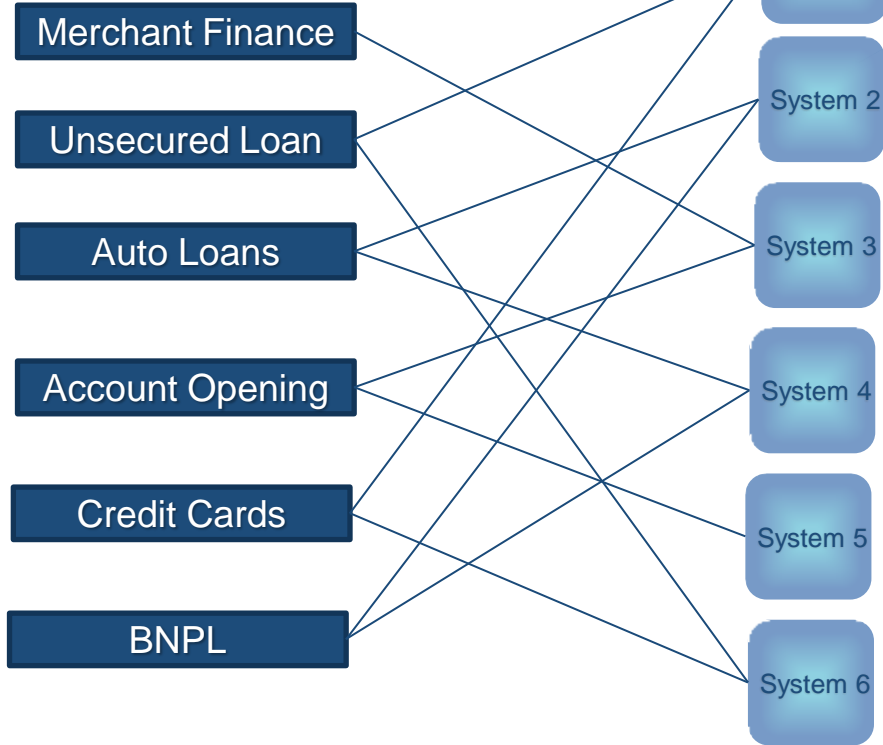



Perfios Credit Gateway

Consumers

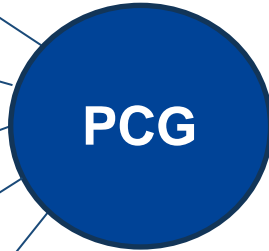

A
P
I

G
a
t
e
w
a
y

Lender





Perfios Credit Gateway

Consumers

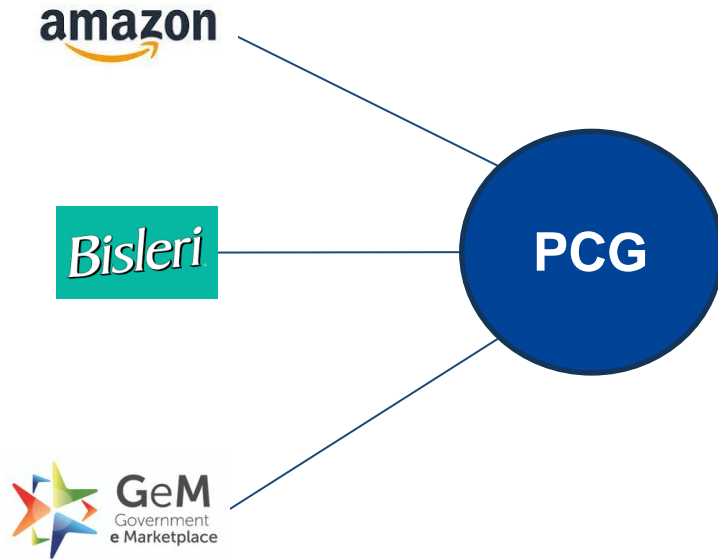

A
P
I

G
a
t
e
w
a
y

Lender





Different Journey

Consumers

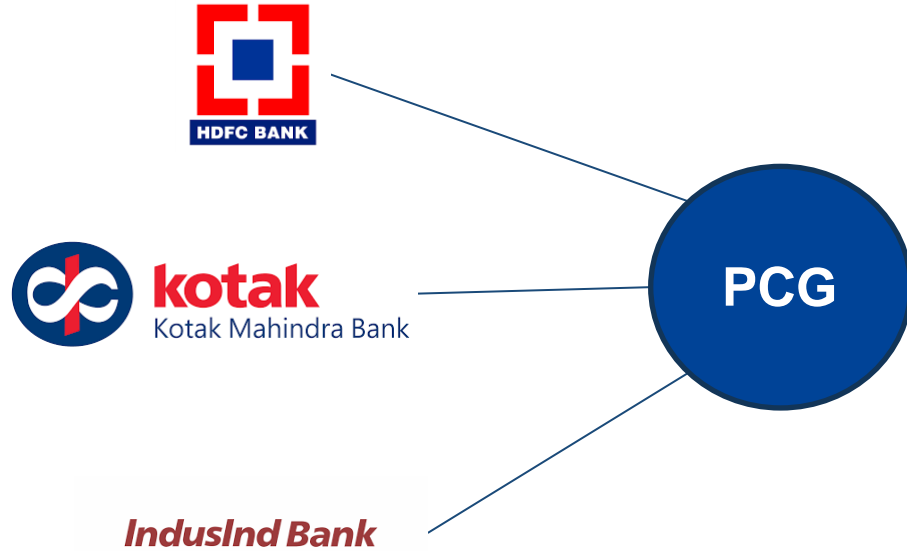

Market place



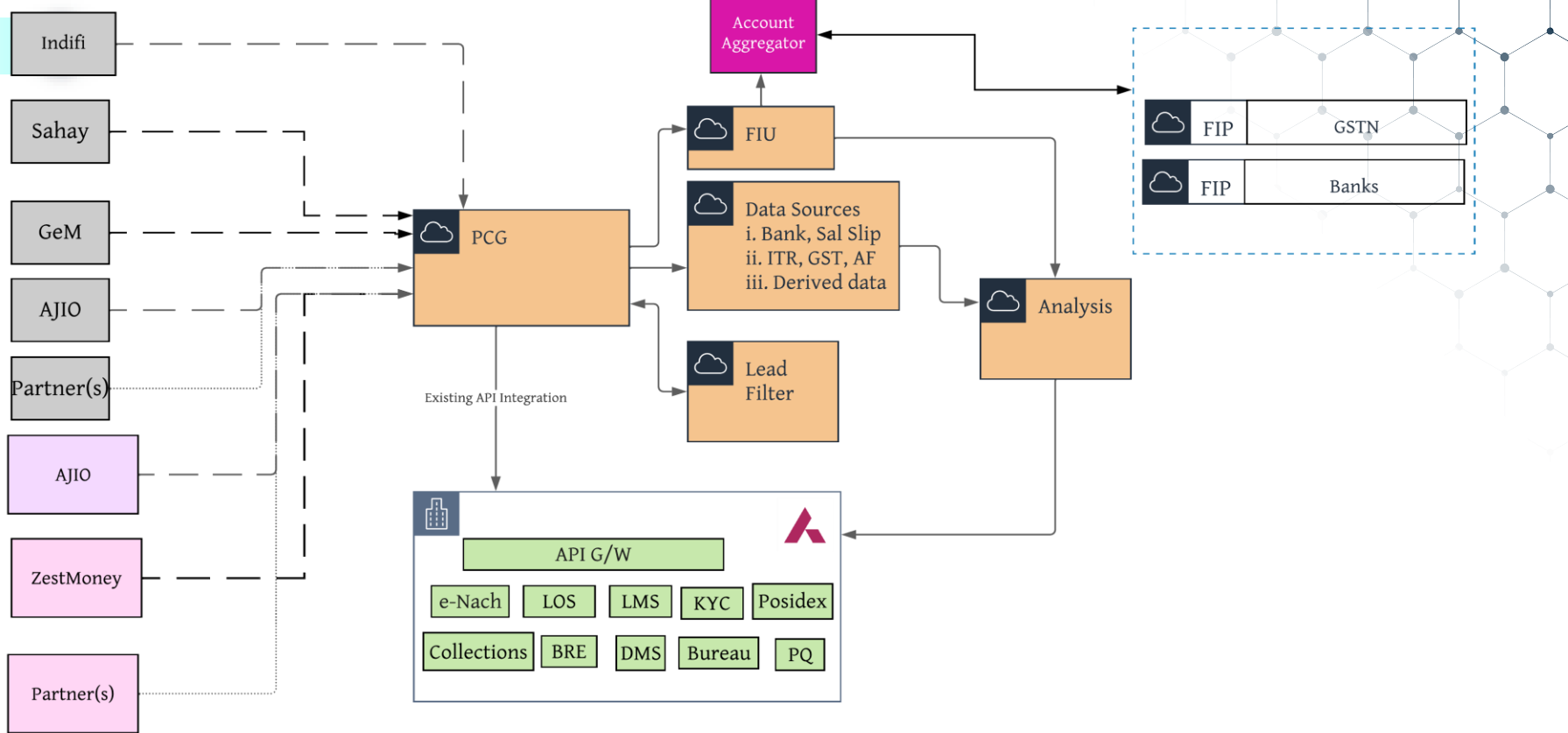

Custom API from PCG
 Whitelabelled Integration
 Retail Partners
 SME Partners
 Perfios Systems
 Axis Systems
 Any AA



100+ micro-services

Pre-integrated into the Platform

❖ Individual Verification



- ❖ Individual PAN
- ❖ Driving License
- ❖ Indian Passport
- ❖ Voter ID
- ❖ Email ID Verification
- ❖ GST Verification

❖ Address Validation



- ❖ LPG (LPG ID)
- ❖ Mobile (Mobile No.)
- ❖ Electricity (Consumer No.)
- ❖ Land Record Verification

❖ Employment Verification



- ❖ Dentist Verification
- ❖ Doctor Verification
- ❖ Insurance Agent Verification
- ❖ Architect Verification
- ❖ ICWAI Certification
- ❖ Company Secretary Verification

❖ Customer Credit Assessment



- ❖ Bank Statement Analysis
- ❖ Credit Risk Monitoring
- ❖ GST Analysis
- ❖ IT Returns Analysis
- ❖ Credit Assessment Memo

❖ Vertical Solutions



- ❖ Loan Origination Platform
- ❖ Customer Onboarding Platform
- ❖ Chat Bot
- ❖ Credit Monitoring Solution
- ❖ Video KYC
- ❖ Vendor Management

❖ Alternate Data



- ❖ SMS Data
- ❖ Credit Rating Data
- ❖ Transactional Data
- ❖ Satellite Data
- ❖ Stock Price & Market Data
- ❖ Debit/Credit Card Transaction Data

❖ Document Verification



- ❖ Cheque
- ❖ Bank Statement
- ❖ Bank Account Verification
- ❖ ITR (26 AS) Extraction
- ❖ Electricity
- ❖ LPG
- ❖ Vehicle Registration
- ❖ ID Card OCR Extraction

❖ Others



- ❖ Legal Verification
- ❖ Aadhaar Vault
- ❖ eNACH Mandates
- ❖ Contract Execution (eStamping)
- ❖ eSignature
- ❖ Account Verification – Penny Drop
- ❖ Payment Solutions
- ❖ Link based Collection
- ❖ Cloud Telephone

❖ Bureau Integration



- ❖ CIBIL
- ❖ EXPERIAN
- ❖ EQUIFAX
- ❖ CRIF HIGHMARK

PCG - Features



- Handle both OCEN & Proprietary technology of partners



- Handle all types of lending programs such as AL, PL, HL, BNPL, Invoice Financing, PO Financing, WC, BL & SC



- Provides API & White labelled solution (both desktop & mobile)



- Handles different data such as
 - Partner propriety data
 - Bank statement
 - ITR, GST
 - Salary slip



- Pre-built with lead filtering, BRE & analysis



- Handles different data ingress such as AA, e-Statement, Scanned statement



- Prepares Pre-qualified (PQ) for ETB



- Pre-integrated with partners such as
 - GeM (PO Financing)
 - GST Sahay (Invoice Financing)
 - ZestMoney (BNPL)
 - AJIO
 - Indifi



- Realtime RBAC dashboard



- Provide detailed MIS & Reconciliation report

Applicant Journey

Full-stack API & UI driven





Growth >

Overview

Hi Rajini, you are eligible upto 50 lakhs of Business Loan!

[APPLY NOW](#)



128
Clients

32
Completed tasks

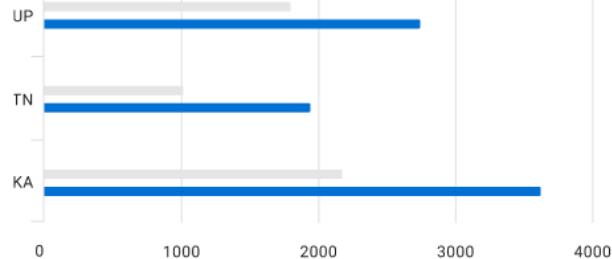

2
Notifications

4
Reports

Top States

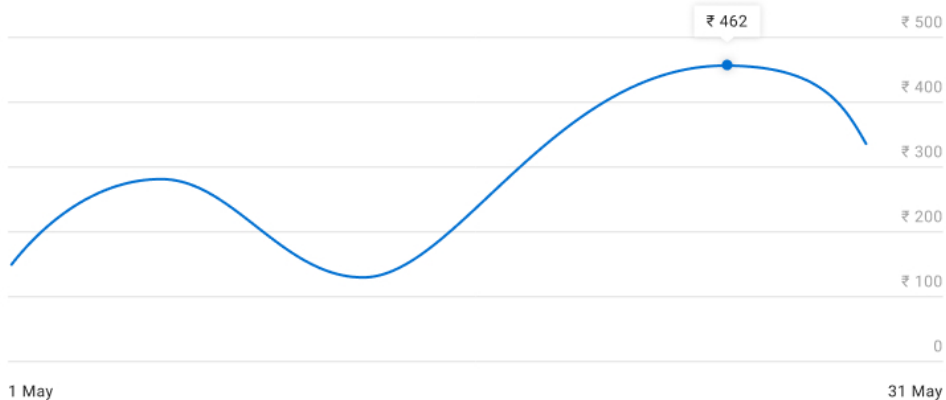

Sales



Orders

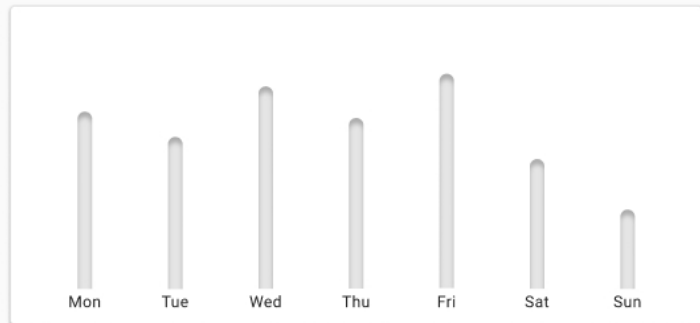



Loan Application



Document Collection



Loan Disbursal

Personal Information

First Name

Rajini

Mobile Number

+91 9923458765



PAN

BJNVP01926D



Income Range

5 - 10 lakhs



Current Work Experience

3.5

in years

Loan Information

How much loan is required?

35,00,000

Max 1 Crore

Last Name

Veturi

Email ID

rajini.v@gmail.com



Employer Name

HIDATO INDUSTRIES PVT LTD



Location

Tirupati

Total Work Experience

8

in years

Tenure

4

Max 5 years

SAVE AND NEXT



Loan Application



Document Collection



Loan Disbursal

KYC Documents iVerify your Aadhaar
(Mandatory)

Verify your voter ID

Banking Details iShare using Account
Aggregator (AA)Share using Net-Banking
login of your bank accountUpload PDF statements
provided by your bankIncome Tax Details iShare using your income
tax E-filing loginUpload tax statements in
PDF format[REVIEW & SUBMIT LOAN APPLICATION](#)

You can submit your loan application after providing all the details.



Loan Application



Document Collection



Loan Disbursal

KYC Documents iVerify company address
(Mandatory)Verify your Udyam
(Mandatory)Banking Details iShare using Net-Banking
login of your bank accountUpload PDF statements
provided by your bankGSTN Details iShare using your invoice
details using GSTN Portal[REVIEW & SUBMIT LOAN APPLICATION](#)

You can submit your loan application after providing all the details.



Loan Application



Document Collection



Loan Disbursal

KYC Documents iVerify your Aadhaar
(Mandatory)Banking Details iShare using Account
Aggregator (AA)Upload PDF statements
provided by your bankSalary Slip iUpload last 3 month
salary slips in PDF format[REVIEW & SUBMIT LOAN APPLICATION](#)

You can submit your loan application after providing all the details.



Loan Application



Document Collection



Loan Disbursal

KYC Documents



Verify company address
(Mandatory)

Banking Details



Share using Account
Aggregator (AA)

Income Tax Details

Select an Account Aggregator

CANCEL



Perfios AA

By Perfios Account Aggregation Services Pvt. Ltd.



Finvu AA

By Cookiejar Technologies Pvt. Ltd.



Onemoney

By Finsec AA Solutions Pvt. Ltd.

CONTINUE WITH PERFIOS AA



Verify your voter ID



Upload PDF statements
provided by your bank





Loan Application



Document Collection



Loan Disbursal

Share banking details using Net-Banking login

[X CANCEL AND GO BACK](#)

Your credentials are required to get your banking details for providing you with suitable loan offer. Your credentials are never stored with us in this process



Select a Bank

Axis Bank



Login ID

rajini.veturi



Password

I agree to the [terms and conditions](#)**PROCEED**

Your bank may ask you to enter OTP or CAPTCHA in the next steps



Loan Application



Document Collection



Loan Disbursal

Banking Details 

You have successfully shared your Banking details for the loan application.

Net-Banking Transaction Reference Number: **BNJKKDGJSN0036**

[SHARE DETAILS OF ANOTHER BANK ACCOUNT](#)**Income Tax Details** 

You have successfully shared your Income Tax details for the loan application.

Transaction Reference Number: **BNJKKDGJSN0036**

[REVIEW & SUBMIT LOAN APPLICATION](#)

You can submit your loan application after providing all the details.



Loan Application



Document Collection



Loan Disbursal



Hi Rajini,
Your Loan application is successfully submitted

Application status will be updated in the next 48 hrs





Growth >

Overview

Congrats, Business Loan approved for 35 lakhs!!

[COMPLETE APPLICATION](#)



128
Clients

32
Completed tasks

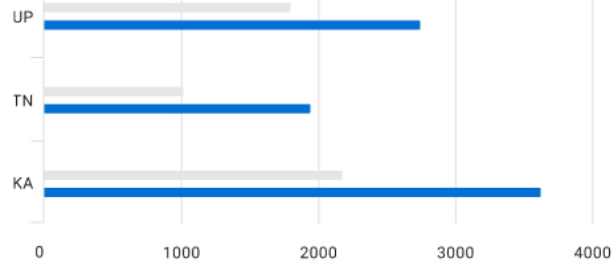

2
Notifications

4
Reports

Top States

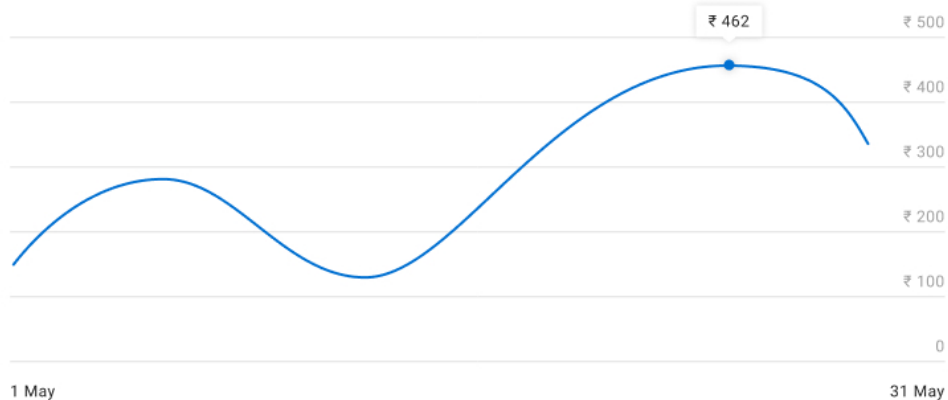

Sales



Orders

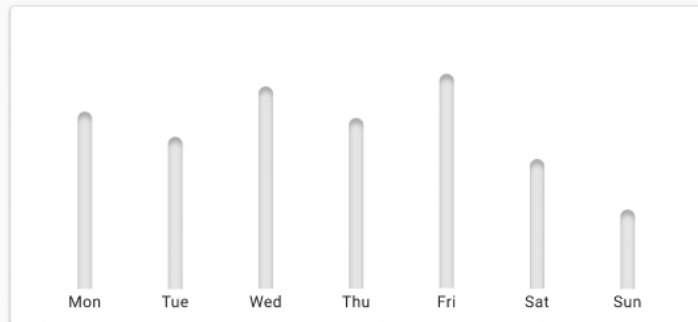



Loan Application



Document Collection



Loan Disbursal

Congrats! You have received a Business Loan offer from Axis Bank

Sanction Letter

[✕ REJECT THE LOAN OFFER](#)

Loan Amount	35,00,000 INR
Tenure	25 Years
ROI	9.25%
Repayment Plan	28,309 every month
Repayment Mode	28,309 every month
Processing Fee	3,500 INR

[PROCEED TO LOAN AGREEMENT](#)



Loan Application



Document Collection



Loan Disbursal

Complete your Business Loan Application Online

Loan Agreement

[X REJECT THE LOAN OFFER](#)

Both parties represent covenants and warrant to each other that:

- (a) He/She has read all the terms and conditions, privacy policy, and other material available at the website of Fairassets Technologies India Private Limited herein after referred to as faircent.
- (b) They unconditionally agree to abide by the terms and condition, privacy policy.
- (c) The information and financial details submitted by him/her on the website of Faircent.
- (d) They understand that Faircent only facilitates meeting of lender and borrowers and is not engaged or is responsible for either lending or ensuring the borrower shall repay the borrowed amount on the time.
- (e) They understand that Faircent only facilitates meeting of lender and borrowers and is not engaged or is responsible for either lending or ensuring the borrower shall repay the borrowed amount on the time.

[I ACCEPT](#)



Loan Application



Document Collection



Loan Disbursal

Complete your Business Loan Application Online

Set up your e-NACH with your bank account

[✕ REJECT THE LOAN OFFER](#)



xxxxxxx6250

Rajini Veturi



Add another account



Loan Application



Document Collection



Loan Disbursal

Thank you for completing the online application



You have successfully accepted the loan offer for 35,00,000 INR

Our representative will reach out to you within 24 hours for further documentation

Loan Reference Number: [a8cc6822bd4bbb4eb](#) 

Dashboards

for both lenders and marketplaces

Dashboard

Last 7 Days ▾

10,459 TOTAL
Applications

350 TOTAL
Disbursed

80 TOTAL
Rejected

15 Pending Documentation

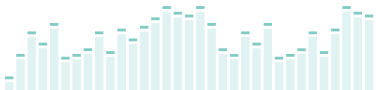

1 Pending Offer Acceptance



10 Pending Disbursement

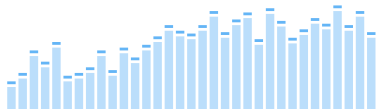

8 Failed Transaction



LSP Disbursals / Lender



LSP	Loan Type	Amount	Date - Time	Status
Amazon	Credit Card	₹ 10,000.00	dd/mm/yyyy - hh:mm:ss	✔ Approved
JustDial	Unsecured Loan	₹ 10,000.00	dd/mm/yyyy - hh:mm:ss	⚠ Pending Docs
Uber	Overdraft	₹ 10,000.00	dd/mm/yyyy - hh:mm:ss	✔ Approved
JustDial	Unsecured Loan	₹ 10,000.00	dd/mm/yyyy - hh:mm:ss	✘ Rejected
Amazon	Credit Card	₹ 10,000.00	dd/mm/yyyy - hh:mm:ss	✔ Disbursed

Dashboard

Transactions

Entities

Health Check

Settings

Health Check



Timeouts Failures

Search

All Lenders ▾

Dec 25, 2021 - Jan 5, 2022 ▾

Advanced Search

Download

Transaction ID	User Name	Timeout Category	Date - Time [^]	LSP	Lender
bec116e4...6f-a0	Vikas Kumar	Loan Acceptance	dd/mm/yyyy hh:mm:ss	Amazon	IIFL
bec116e4...6f-a0	Vikas Kumar	Transaction	dd/mm/yyyy hh:mm:ss	Amazon	Tata Capital
bec116e4...6f-a0	Vikas Kumar	Disbursment	dd/mm/yyyy hh:mm:ss	Amazon	Tata Capital
bec116e4...6f-a0	Vikas Kumar	Repayment	dd/mm/yyyy hh:mm:ss	Amazon	IIFL
bec116e4...6f-a0	Vikas Kumar	Loan Application	dd/mm/yyyy hh:mm:ss	Amazon	Tata Capital
bec116e4...6f-a0	Vikas Kumar	Loan Grant	dd/mm/yyyy hh:mm:ss	Amazon	IIFL
bec116e4...6f-a0	Vikas Kumar	Consent	dd/mm/yyyy hh:mm:ss	Amazon	IIFL

Showing 1-7 of 7 items

Rows per page

 ▾

1

- Dashboard
- Transactions
- Entities
- Health Check
- Settings

Transactions

Search

All Organisations ▼

Dec 25, 2021 - Jan 5, 2022 ▼

Advanced Search

Download

Transaction ID	LSP	Applicant	Loan Type	Amount	Date - Time ^	Status
bec116e4...6f-a0	Amazon	ABC Pvt. Ltd.	Invoice Financing	₹ 10,000.00	C dd/mm/yyyy - hh:mm:ss U dd/mm/yyyy - hh:mm:ss	Approved
bec116e4...6f-a0	Amazon	ABC Pvt. Ltd.	Invoice Financing	₹ 10,000.00	C dd/mm/yyyy - hh:mm:ss U dd/mm/yyyy - hh:mm:ss	Pending Docs
bec116e4...6f-a0	Amazon	ABC Pvt. Ltd.	Invoice Financing	₹ 10,000.00	C dd/mm/yyyy - hh:mm:ss U dd/mm/yyyy - hh:mm:ss	Rejected
bec116e4...6f-a0	Amazon	ABC Pvt. Ltd.	Invoice Financing	₹ 10,000.00	C dd/mm/yyyy - hh:mm:ss U dd/mm/yyyy - hh:mm:ss	Approved
bec116e4...6f-a0	Amazon	ABC Pvt. Ltd.	Invoice Financing	₹ 10,000.00	C dd/mm/yyyy - hh:mm:ss U dd/mm/yyyy - hh:mm:ss	Approved
bec116e4...6f-a0	Amazon	ABC Pvt. Ltd.	Invoice Financing	₹ 10,000.00	C dd/mm/yyyy - hh:mm:ss U dd/mm/yyyy - hh:mm:ss	Pending Docs
bec116e4...6f-a0	Amazon	ABC Pvt. Ltd.	Invoice Financing	₹ 10,000.00	C dd/mm/yyyy - hh:mm:ss U dd/mm/yyyy - hh:mm:ss	Approved

Showing 1-7 of 7 items

Rows per page

Dashboard

Transactions

Entities

Health Check

Settings



Write to us at Vamsee.Yalamanchi@perfios.com